

# Georgia

**Standard & Armless** (All 4 seat items ship as one piece if stationary, two pieces if motion installed)

**2 Piece Curve Sectional & Ottomans**

1/03/2010

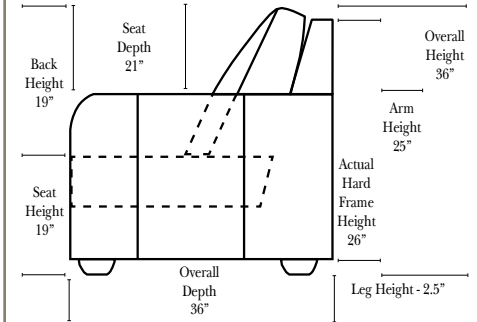
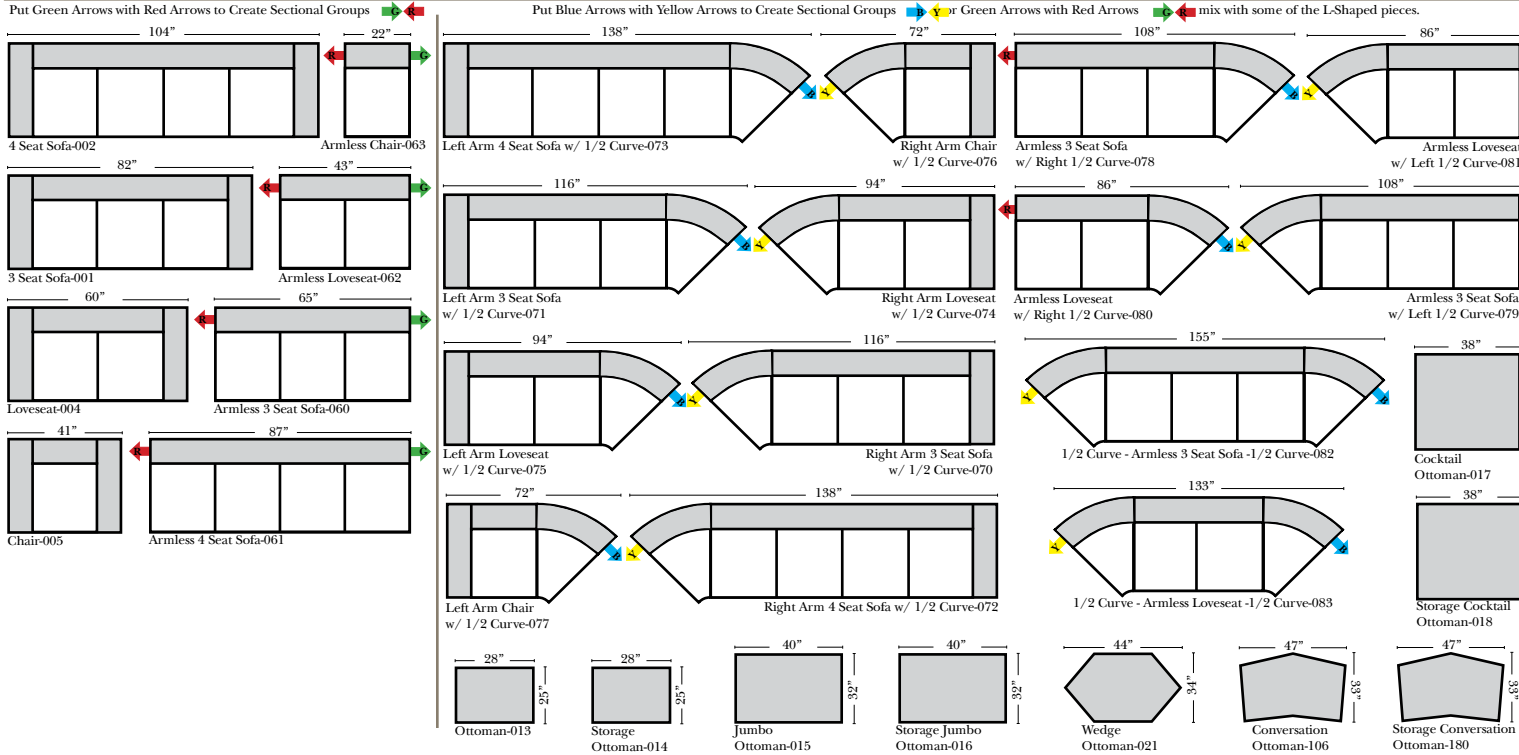

### Features

**Standard:**

- Available in Full & Top Grain Leathers
- Available in Luxury Fabrics
- All Hardwood Frames
- Legs are standard as Walnut color, available in Cherry, Espresso, Honey Oak, & Natural

**Options:**

- Down Seats & Backs (additional Charge)
- No. 33 Firm Foam

**Sleeper Options:** (All the below options are at additional charges)

- Full Sleeper available w/ Standard Mattress
- Deluxe Innerspring Mattress: Full
- Air Dream Coil Mattress: Full Only

### L-Shape / 90 Degree Sectional

(All 4 seat items ship as one piece if stationary, two pieces if motion installed)

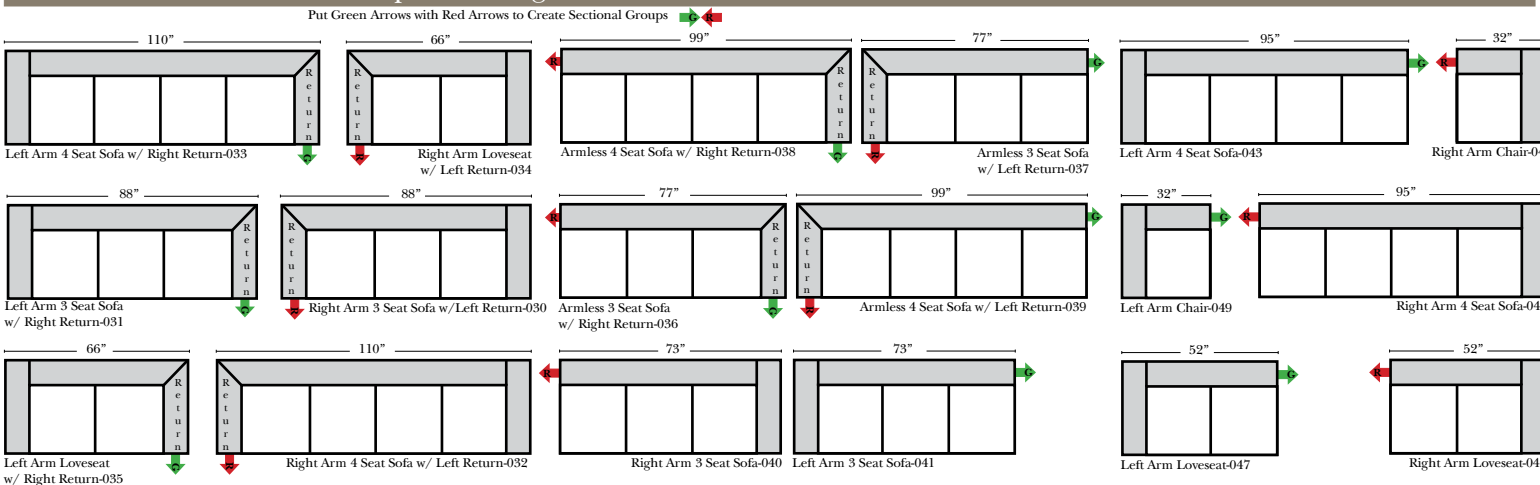

**Note:**

All Dimensions are approximate, if accuracy is crucial, please contact us for validation of the dimensions shown. However, a 1" to 2" variance can still apply due to foam and upholstery.



# Georgia

## Chaise & Conversation Sectionals

Put Green Arrows with Red Arrows to Create Sectional Groups  
Put Orange Arrows with Tan Arrows to Create Sectional Groups

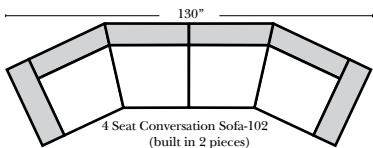
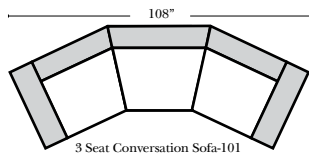
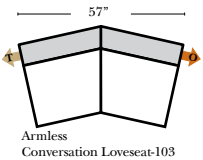
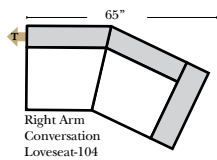
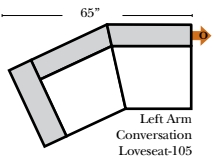
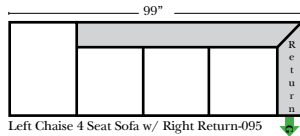
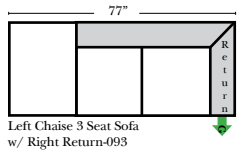
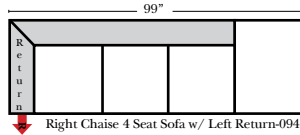
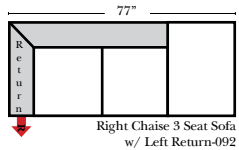
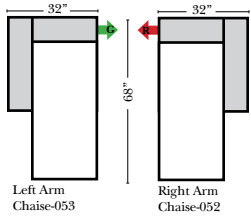

## Sleepers

Put Green Arrows with Red Arrows to Create Sectional Groups  
Put Blue Arrows with Yellow Arrows to Create Sectional Groups

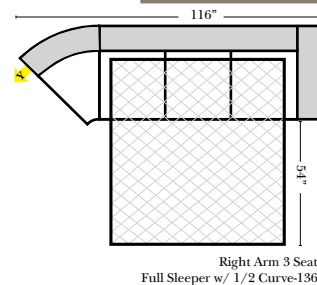
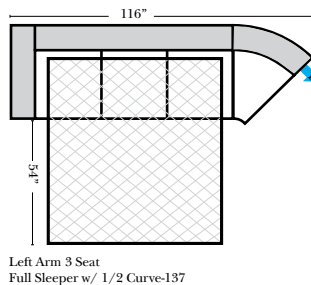
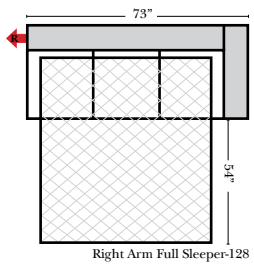
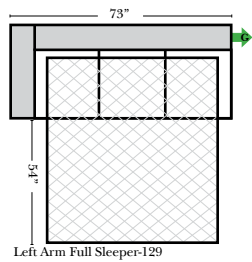
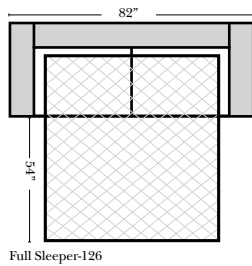

## Suggested Configurations

1/03/2010

The Suggested Configurations below are only a sample of what the imagination can create, please enjoy creating the configuration that fits your lifestyle, using the ideas below and from the items on the opposite page.

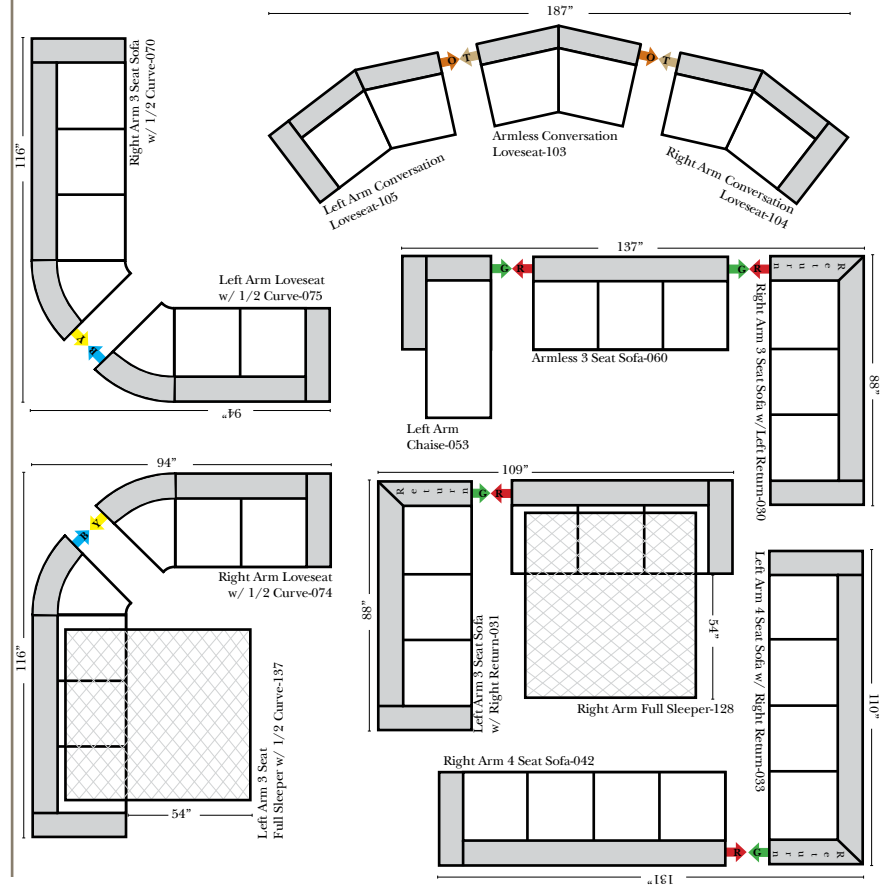

## Sleepers (Cont.)